

ASSP for Mobile Telephone

VCO (700 to 2500 MHz)

VC-80 Series

■ DESCRIPTION

With excellent C/N characteristics and low current consumption, this VCO series is ideal for PDC, PHS, CDMA, PCS and GSM mobile communication equipment. The VC-80 series can be used in any frequency band in the 700MHz to 2500MHz range. The device utilizes FUJITSU MEDIA DEVICE's high-frequency design technology, high-density mounting technology, and frequency adjustment technology to provide a high level of reliability in addition to high performance and small size.

■ FEATURES

- Superior noise characteristics (C/N, S/N)
- High level of stability in response to ambient temperature and load variations
- FUJITSU MEDIA DEVICE's proprietary fabrication process provides the uniformity of the central frequency distribution
- Small size, light-weight, slim-package : 5.5 × 4.8 × 1.6 mm (Typ.)
- SMD-type taping specifications suitable for automatic mounting and reflow soldering

■ PACKAGE

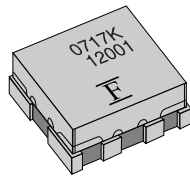

VC-80 Series

■ PIN ASSIGNMENT

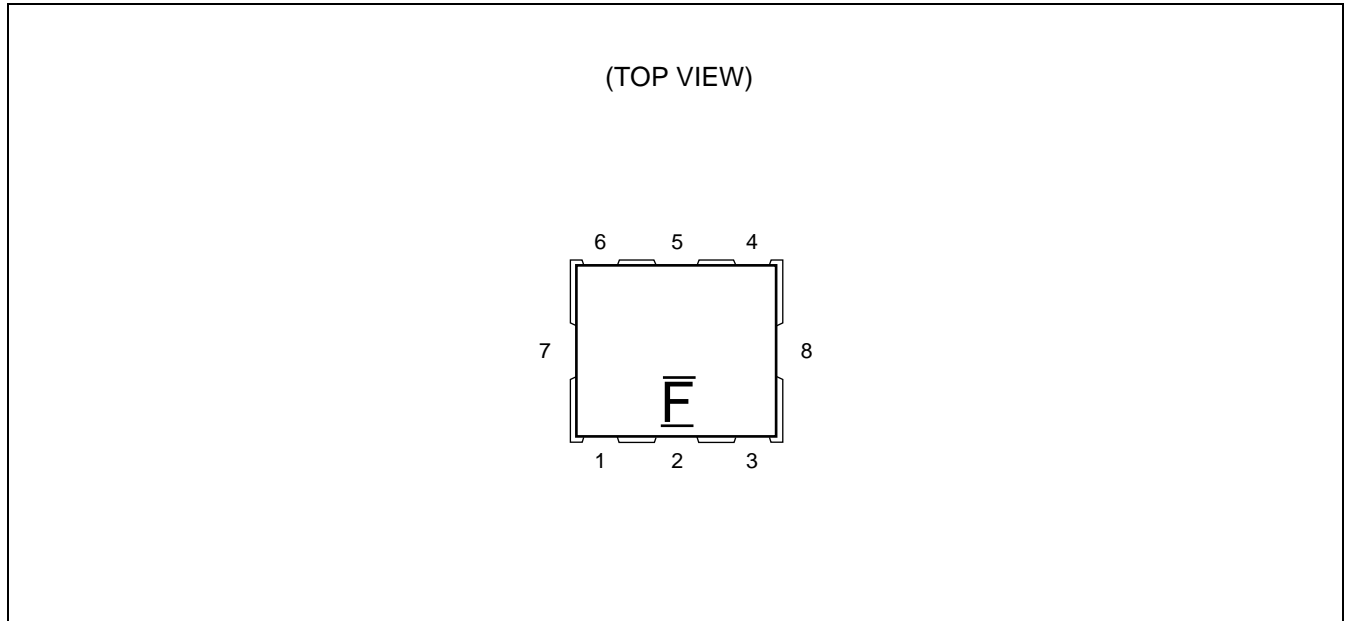

■ PIN DESCRIPTION

Pin No.	Symbol	Description
1	V _t	Control voltage
2	GND	GND
3	V _{cc}	Power supply voltage
4	OUT	Output
5	GND	GND
6	GND	GND
7	GND	GND
8	GND	GND

■ PRODUCT LINEUP (STANDARD MODELS)

System	Center Frequency (MHz)	Band Width (MHz)	Power Supply Voltage (V)	Part Number
PDC800 makitori	717	±37.5	2.2 ± 0.2	VC-2R2A80-0717K
cdmaOne	739	±19.5	2.8 ± 0.1	VC-2R8A80-0739A
PHS Data communication device	1668	±18.3	3.0 ± 0.2	VC-3R0A80-1668N
K-PCS	1635	±15	2.8 ± 0.15	VC-2R8A80-1635L
CDMA	967	±13	2.8 ± 0.15	VC-2R8A80-0967L

■ ELECTRICAL CHARACTERISTICS

1. For PDC800 makitori (Part number : VC-2R2A80-0717K)

• Absolute Maximum Ratings

Parameter	Symbol	Rating		Unit
		Min.	Max.	
Input DC voltage	V _{cc}	—	+ 3.0	V
Control voltage	V _t	—	+ 3.0	V
Operating temperature	T _a	-20	+70	°C
Storage temperature	T _{stg}	-30	+80	°C
Storage humidity	H _{stg}	5	95	%

WARNING: VCO can be permanently damaged by application of stress (voltage, temperature, humidity, etc.) in excess of absolute maximum ratings. Do not exceed these ratings.

• Electrical Characteristics

(T_a = +25 °C ± 3 °C)

Parameter	Symbol	Conditions	Value			Unit
			Min.	Typ.	Max.	
Current consumption	I _{cc}	V _{cc} = 2.2 V, V _t = 1.4 V	—	—	6.8*	mA
Frequency	f _{min}	V _{cc} = 2.2 V, V _t = 0.4 V	—	—	680.0*	MHz
Frequency	f _{max}	V _{cc} = 2.2 V, V _t = 2.4 V	755.0*	—	—	MHz
Control voltage sensitivity	k _v	(f _{max} - f _{min}) / 2.0	44.0	—	56.0	MHz/V
Oscillator output	P _o	V _{cc} = 2.2 V, V _t = 1.4 V	-7.0*	—	-1.0*	dBm
C/N	C/N	V _{cc} = 2.2 V, V _t = 1.4 V, Offset = 50 kHz, BW = 21 kHz	67.0* 69.0	—	—	dBc/Hz
S/N	S/N	V _{cc} = 2.2 V, V _t = 1.4 V, Dev = ±2 kHz, B.W. = 0.3 kHz to 3 kHz	28.0*	—	—	dBc/Hz
Higher harmonics	H _s	V _{cc} = 2.2 V, V _t = 1.4 V, Up to 3rd	—	—	-10.0*	dBc
Power supply variation	Push	V _{cc} = 2.2 V ± 0.2 V, V _t = 1.4 V	—	—	±600*	kHz
Load variation	Pull	V _{cc} = 2.2 V, V _t = 1.4 V, VSWR = 2 ALL PHASE	—	—	±500*	kHz
Temperature drift	T _d	T _a = +25 °C ± 45 °C	—	—	±3000*	kHz

* : T_a = -20 °C to +70 °C

VC-80 Series

2. For cdmaOne (Part number : VC-2R8A80-0739A)

• Absolute Maximum Ratings

Parameter	Symbol	Rating		Unit
		Min.	Max.	
Input DC voltage	V _{cc}	—	+ 3.2	V
Control voltage	V _t	—	+ 3.2	V
Operating temperature	T _a	-30	+80	°C
Storage temperature	T _{stg}	-40	+85	°C
Storage humidity	H _{stg}	5	95	%

WARNING: VCO can be permanently damaged by application of stress (voltage, temperature, humidity, etc.) in excess of absolute maximum ratings. Do not exceed these ratings.

• Electrical Characteristics

(T_a = +25 °C ± 3 °C)

Parameter	Symbol	Conditions	Value			Unit
			Min.	Typ.	Max.	
Current consumption	I _{cc}	V _{cc} = 2.8 V, V _t = 1.5 V	—	—	6.5*	mA
Frequency	f _{min}	V _{cc} = 2.8 V, V _t = 0.5 V	—	—	719.65*	MHz
Frequency	f _{max}	V _{cc} = 2.8 V, V _t = 2.5 V	758.65*	—	—	MHz
Control voltage sensitivity	k _v	(f _{max} - f _{min}) / 2.0	25.0	31.0	37.0	MHz/V
Oscillator output	P _o	V _{cc} = 2.8 V, V _t = 1.5 V	-4.0*	—	2.0*	dBm
C/N	C/N	V _{cc} = 2.8 V, V _t = 1.5 V, Offset = 25 kHz, BW = 1 Hz	108.0*	—	—	dBc/Hz
		V _{cc} = 2.8 V, V _t = 1.5 V, Offset = 50 kHz, BW = 1 Hz	113.0*	—	—	dBc/Hz
		V _{cc} = 2.8 V, V _t = 1.5 V, Offset = 100 kHz, BW = 1 Hz	118.0*	—	—	dBc/Hz
		V _{cc} = 2.8 V, V _t = 1.5 V, Offset = 285 kHz, BW = 1 Hz	128.0*	—	—	dBc/Hz
		V _{cc} = 2.8 V, V _t = 1.5 V, Offset = 900 kHz, BW = 1 Hz	138.0*	—	—	dBc/Hz
Higher harmonics	H _s	V _{cc} = 2.8 V, V _t = 1.5 V, Up to 3rd	—	—	-10.0	dBc
Power supply variation	Push	V _{cc} = 2.8 V ± 0.1 V, V _t = 1.5 V	—	—	±500	kHz
Load variation	Pull	V _{cc} = 2.8 V, V _t = 1.5 V, VSWR = 2 ALL PHASE	—	—	±500	kHz
Temperature drift	T _d	T _a = +25 °C ± 55 °C	—	—	±3000*	kHz

* : T_a = -30 °C to +80 °C

3. For PHS (Part number : VC-3R0A80-1668N)

• Absolute Maximum Ratings

Parameter	Symbol	Rating		Unit
		Min.	Max.	
Input DC voltage	V _{cc}	—	+ 3.2	V
Control voltage	V _t	—	+ 3.0	V
Operating temperature	T _a	-20	+70	°C
Storage temperature	T _{stg}	-30	+85	°C
Storage humidity	H _{stg}	5	95	%

WARNING: VCO can be permanently damaged by application of stress (voltage, temperature, humidity, etc.) in excess of absolute maximum ratings. Do not exceed these ratings.

• Electrical Characteristics

(T_a = +25 °C ± 3 °C)

Parameter	Symbol	Conditions	Value			Unit
			Min.	Typ.	Max.	
Current consumption	I _{cc}	V _{cc} = 3.0 V, V _t = 1.25 V	—	—	10.0*	mA
Frequency	f _{min}	V _{cc} = 3.0 V, V _t = 0.6 V	—	—	1649.7*	MHz
Frequency	f _{max}	V _{cc} = 3.0 V, V _t = 1.9 V	1686.3	—	—	MHz
Control voltage sensitivity	k _v	(f _{max} – f _{min}) / 1.3	43.0	—	57.0	MHz/V
Oscillator output	P _o	V _{cc} = 3.0 V, V _t = 1.25 V	-6.0*	—	—	dBm
C/N	C/N	V _{cc} = 3.0 V, V _t = 1.25 V, Offset = 100 kHz, BW = 1 Hz	110.0*	—	—	dBc/Hz
Higher harmonics	H _s	V _{cc} = 3.0 V, V _t = 1.25 V, Up to 3rd	—	—	-15.0	dBc
Power supply variation	Push	V _{cc} = 3.0 V ± 0.2 V, V _t = 1.25 V	—	—	±800	kHz
Load variation	Pull	V _{cc} = 3.0 V, V _t = 1.25 V, VSWR = 2 ALL PHASE	—	—	±1000	kHz
Temperature drift	T _d	T _a = +25 °C ± 45 °C	—	—	±4000*	kHz

* : T_a = -20 °C to +70 °C

VC-80 Series

4. For K-PCS (Part number : VC-2R8A80-1635L)

• Absolute Maximum Ratings

Parameter	Symbol	Rating		Unit
		Min.	Max.	
Input DC voltage	V _{cc}	—	+ 7.0	V
Control voltage	V _t	—	+ 10.0	V
Operating temperature	T _a	-30	+80	°C
Storage temperature	T _{stg}	-40	+85	°C
Storage humidity	H _{stg}	5	95	%

WARNING: VCO can be permanently damaged by application of stress (voltage, temperature, humidity, etc.) in excess of absolute maximum ratings. Do not exceed these ratings.

• Electrical Characteristics

(T_a = +25 °C ± 3 °C)

Parameter	Symbol	Conditions	Value			Unit
			Min.	Typ.	Max.	
Current consumption	I _{cc}	V _{cc} = 2.8 V, V _t = 1.5 V	—	—	8.5	mA
Frequency	f _{min}	V _{cc} = 2.8 V, V _t = 0.5 V	—	—	1620.0*	MHz
Frequency	f _{max}	V _{cc} = 2.8 V, V _t = 2.5 V	1650.0*	—	—	MHz
Control voltage sensitivity	k _v	(f _{max} – f _{min}) / 2.0	22.0	—	—	MHz/V
Oscillator output	P _o	V _{cc} = 2.8 V, V _t = 1.5 V	-3.0	—	1.0	dBm
C/N	C/N	V _{cc} = 2.8 V, V _t = 1.5 V, Offset = 1 kHz, BW = 1 Hz	70.0*	—	—	dBc/Hz
		V _{cc} = 2.8 V, V _t = 1.5 V, Offset = 100 kHz, BW = 1 Hz	111.0*	—	—	dBc/Hz
		V _{cc} = 2.8 V, V _t = 1.5 V, Offset = 1250 kHz, BW = 1 Hz	134.0*	—	—	dBc/Hz
Higher harmonics	H _s	V _{cc} = 2.8 V, V _t = 1.5 V, Up to 3rd	—	—	-10.0*	dBc
Spurious	S _p	V _{cc} = 2.8 V, V _t = 1.5 V	—	—	-70.0*	dBc
Power supply variation	Push	V _{cc} = 2.8 V ± 0.15 V, V _t = 1.5 V	—	—	±700	kHz
Load variation	Pull	V _{cc} = 2.8 V, V _t = 1.5 V, VSWR = 2 ALL PHASE	—	—	±800	kHz
Temperature drift	T _d	T _a = +25 °C ± 55 °C	—	—	±3000*	kHz

* : T_a = -30 °C to +80 °C

5. For CDMA (Part number : VC-2R8A80-0967L)

• Absolute Maximum Ratings

Parameter	Symbol	Rating		Unit
		Min.	Max.	
Input DC voltage	V _{cc}	—	+ 7.0	V
Control voltage	V _t	—	+ 10.0	V
Operating temperature	T _a	-30	+80	°C
Storage temperature	T _{stg}	-40	+85	°C
Storage humidity	H _{stg}	5	95	%

WARNING: VCO can be permanently damaged by application of stress (voltage, temperature, humidity, etc.) in excess of absolute maximum ratings. Do not exceed these ratings.

• Electrical Characteristics

(T_a = +25 °C ± 3 °C)

Parameter	Symbol	Conditions	Value			Unit
			Min.	Typ.	Max.	
Current consumption	I _{cc}	V _{cc} = 2.8 V, V _t = 1.5 V	—	—	7.5*	mA
Frequency	f _{min}	V _{cc} = 2.8 V, V _t = 0.5 V	—	—	954.0*	MHz
Frequency	f _{max}	V _{cc} = 2.8 V, V _t = 2.5 V	980*	—	—	MHz
Control voltage sensitivity	k _v	(f _{max} - f _{min}) / 2.0	18.0	—	28.0	MHz/V
Oscillator output	P _o	V _{cc} = 2.8 V, V _t = 1.5 V	-3.0	—	1.0	dBm
C/N	C/N	V _{cc} = 2.8 V, V _t = 1.5 V, Offset = 1 kHz, BW = 1 Hz	70.0*	—	—	dBc/Hz
		V _{cc} = 2.8 V, V _t = 1.5 V, Offset = 10 kHz, BW = 1 Hz	100.0*	—	—	dBc/Hz
		V _{cc} = 2.8 V, V _t = 1.5 V, Offset = 30 kHz, BW = 1 Hz	110.0*	—	—	dBc/Hz
		V _{cc} = 2.8 V, V _t = 1.5 V, Offset = 60 kHz, BW = 1 Hz	115.0*	—	—	dBc/Hz
Higher harmonics	H _s	V _{cc} = 2.8 V, V _t = 1.5 V, Up to 3rd	—	—	-10.0*	dBc
Spurious	S _p	V _{cc} = 2.8 V, V _t = 1.5 V	—	—	-70.0*	dBc
Power supply variation	Push	V _{cc} = 2.8 V ± 0.15 V, V _t = 1.5 V	—	—	±500	kHz
Load variation	Pull	V _{cc} = 2.8 V, V _t = 1.5 V, VSWR = 2 ALL PHASE	—	—	±600	kHz
Temperature drift	T _d	T _a = +25 °C ± 55 °C	—	—	±3000*	kHz

* : T_a = -30 °C to +80 °C

VC-80 Series

MARKING

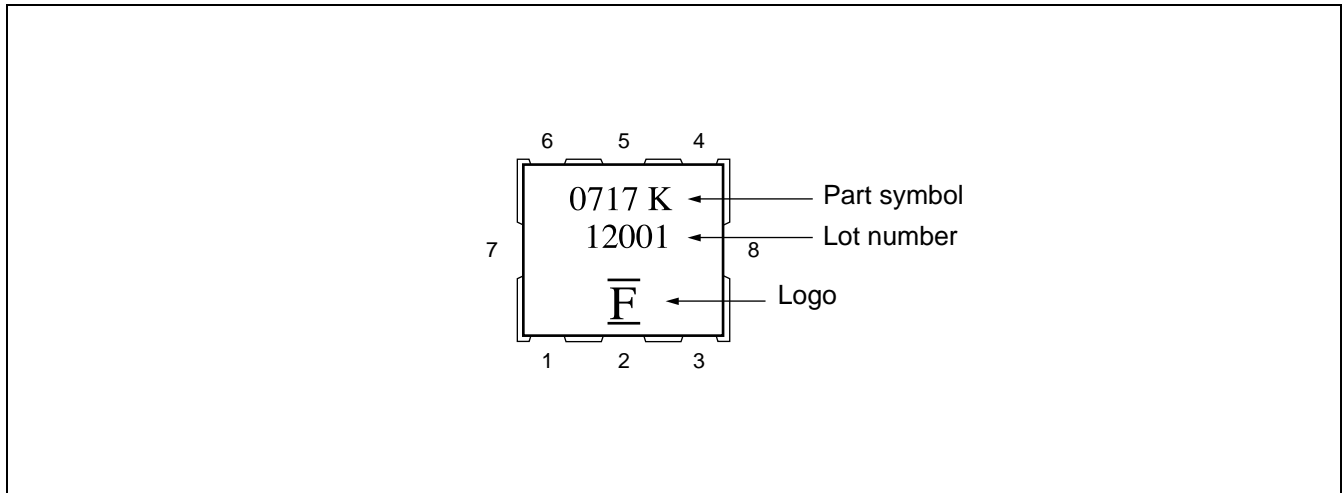

PART NUMBER DESIGNATION

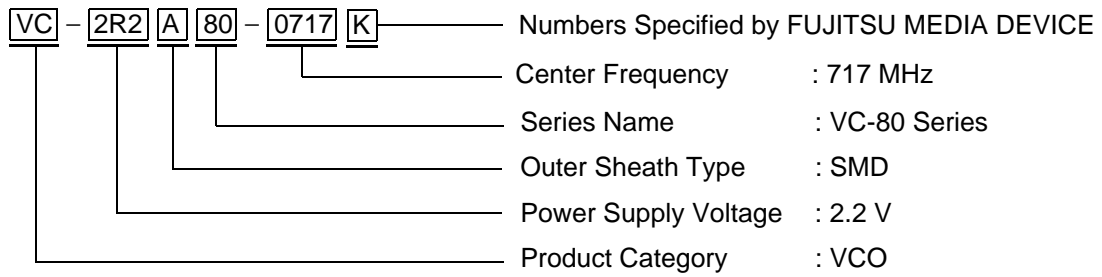

PACKAGE DIMENSION

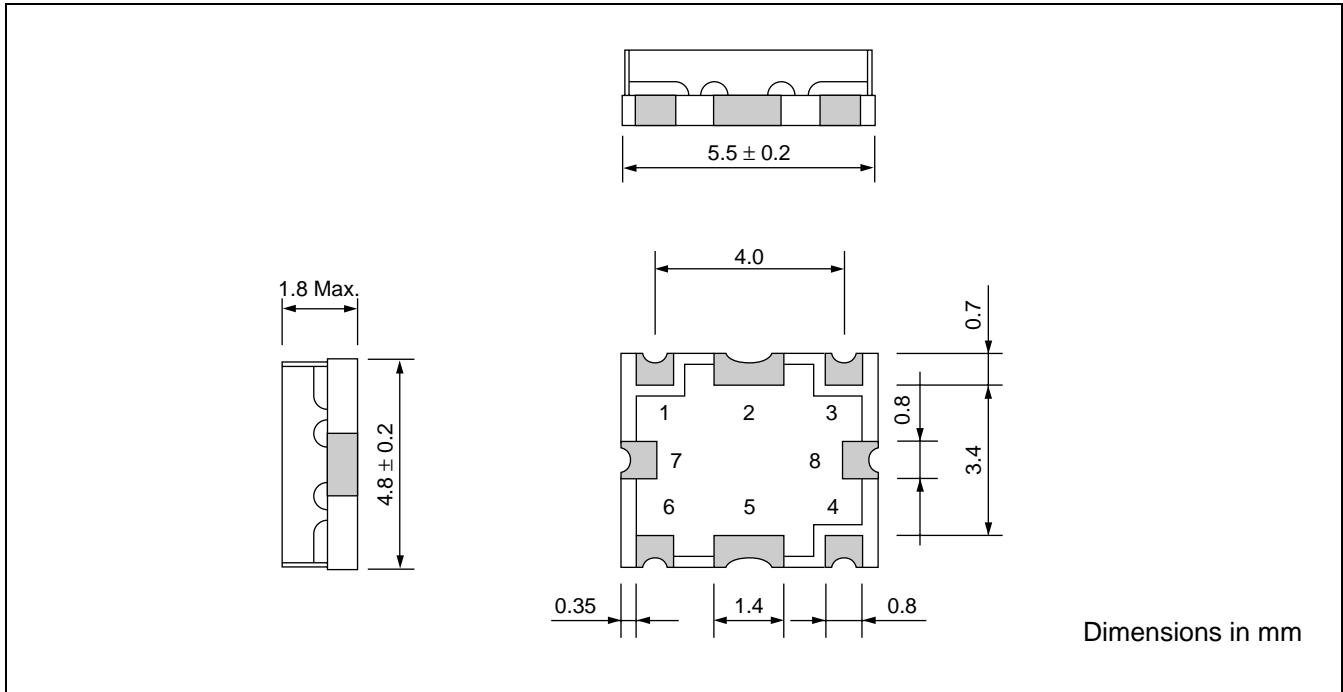

RECOMMENDED PATTERN FOR SOLDERING

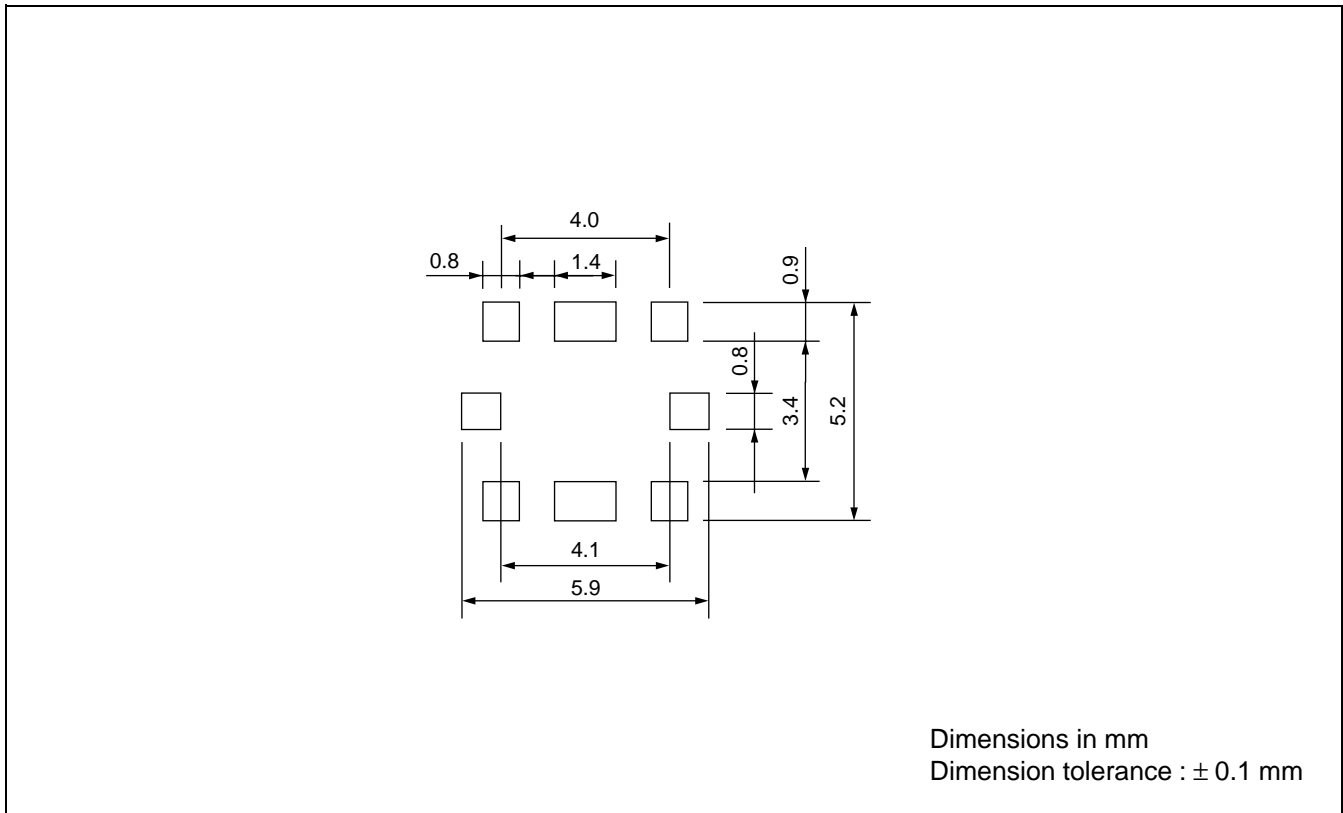

VC-80 Series

■ TAPING AND PACKAGING

(1) Carrier Tape and Packaging

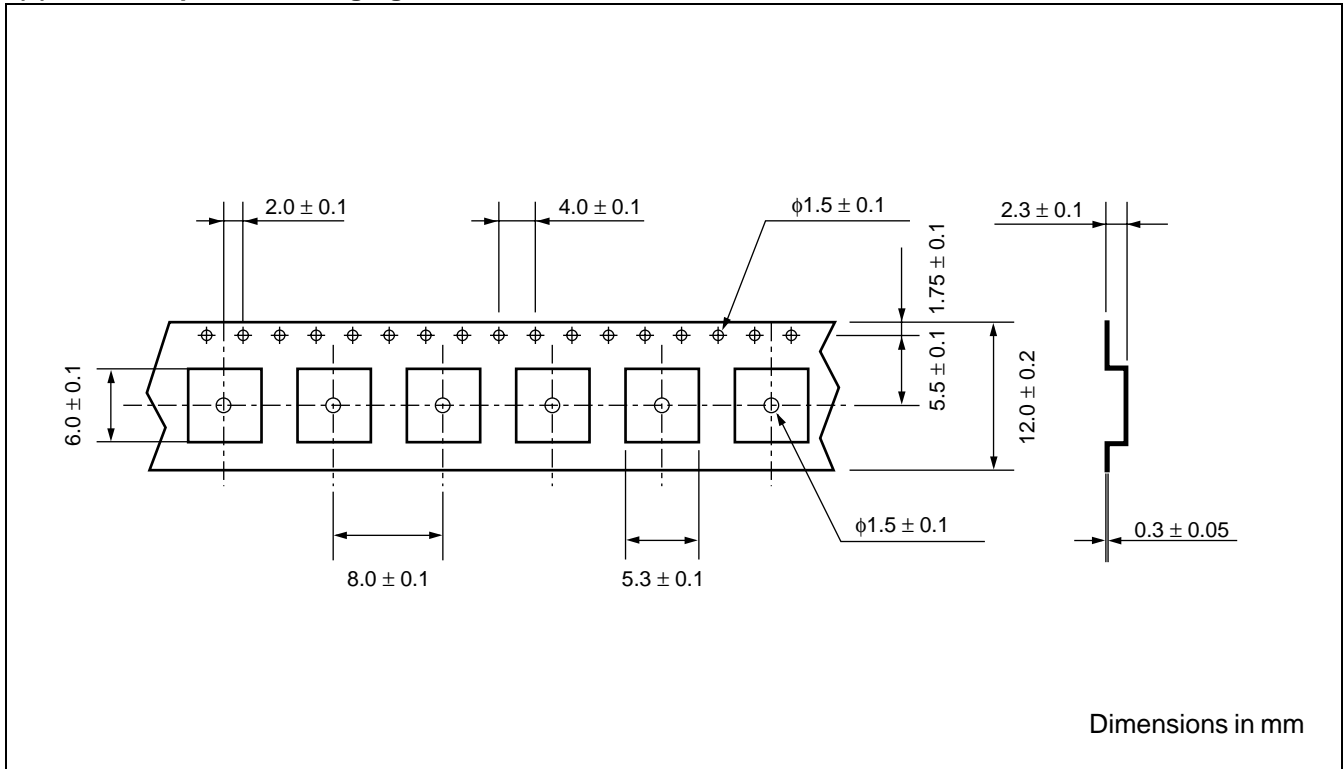

(2) Taping Layout

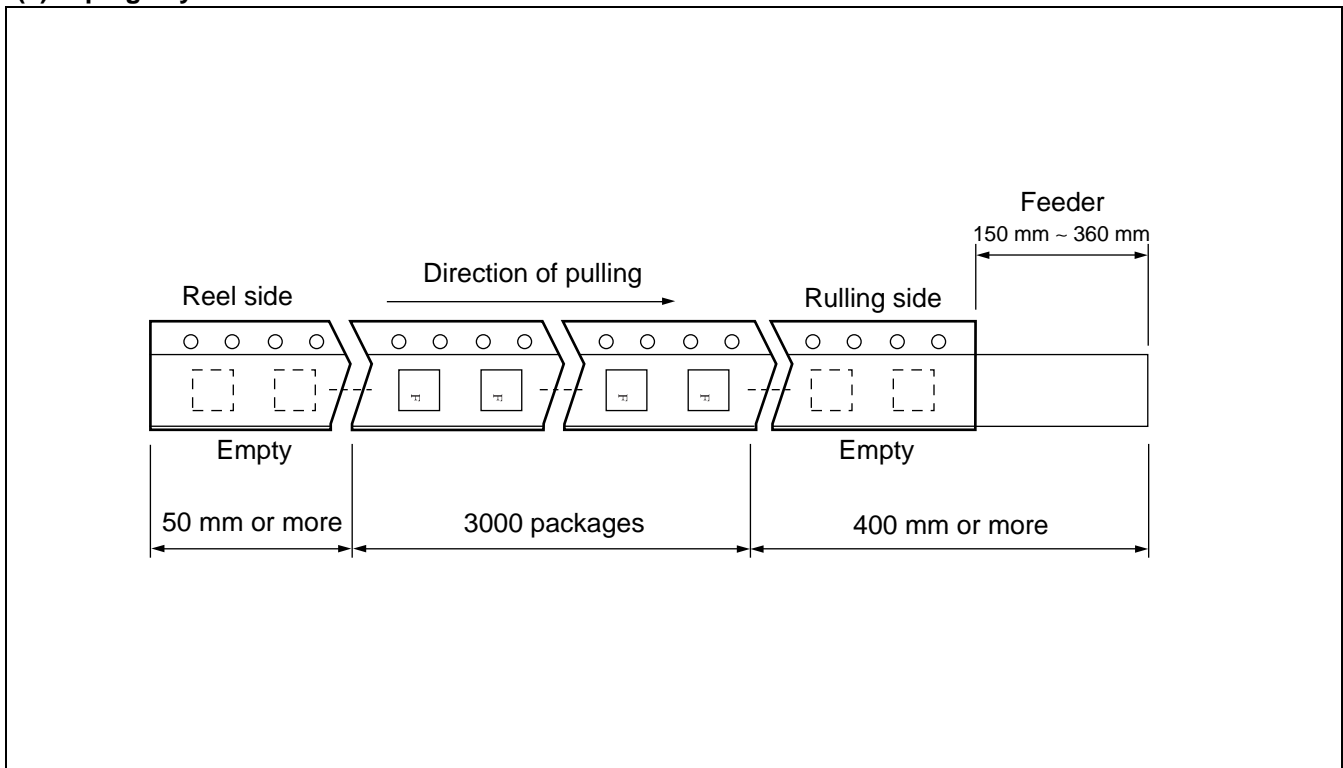

VC-80 Series

REFLOW MOUNTING CONDITIONS (RECOMMENDED)

- Perform mounting using the temperature profile shown below. To prevent thermal stress to the VCO, ensure gentle temperature gradients and use preheating whenever possible. (Recommended preheating: 140 °C to 160 °C for 60 s ± 20 s)
- Always consult FUJITSU MEDIA DEVICE beforehand if mounting more than once.
- Never remove a VCO that has already been mounted and attempt to reuse.
- For mounting, use a general-purpose flux suitable for mounting electronic components.

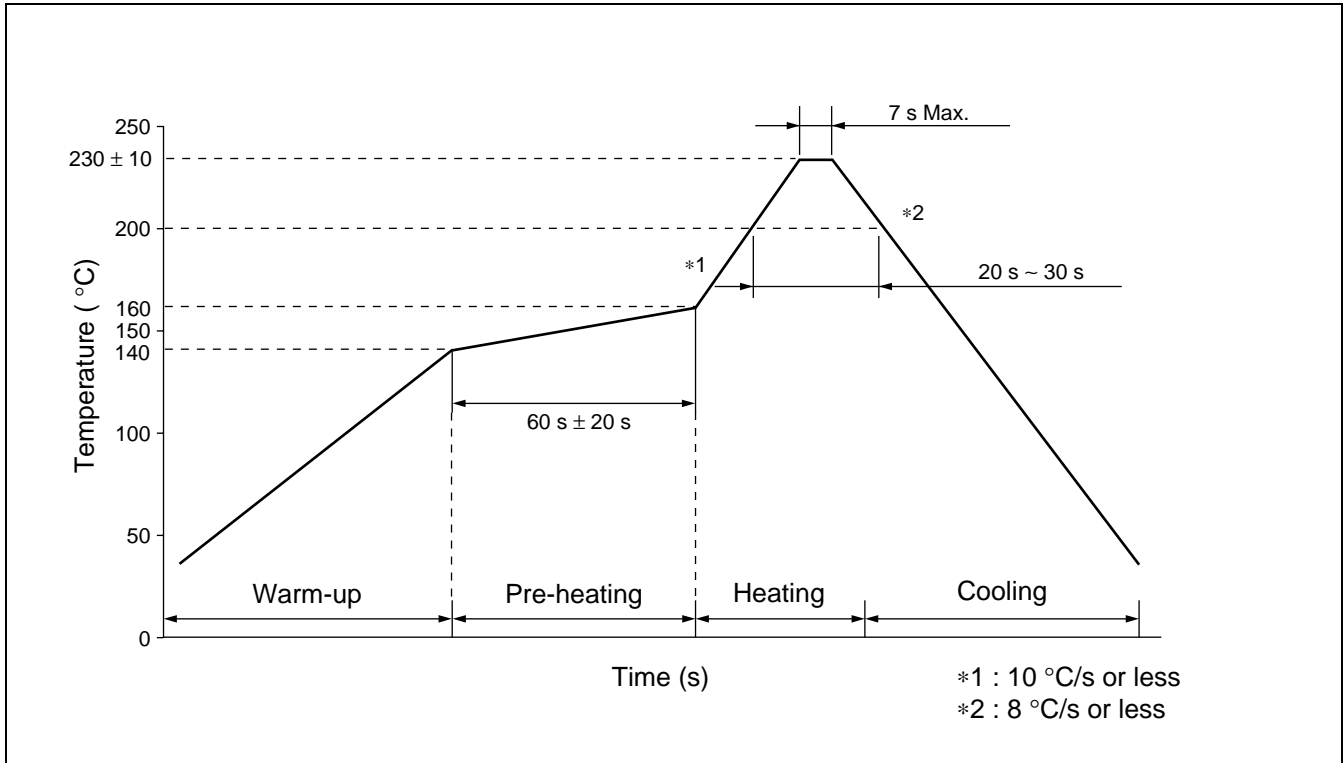

WASHING CONDITIONS

- Washing solution: Use isopropyl alcohol.
- Washing procedure: Immersion or steam cleaning is recommended.
- Washing time: For immersion: Less than 5 minutes at 40 °C or less.
For steam: Less than 2 minutes at 90 °C or less is recommended.

FUJITSU MEDIA DEVICES LIMITED

For further information please contact:

Japan

FUJITSU MEDIA DEVICE LIMITED
International Sales & Marketing DEPT.
Shin-Yokohama Square Bldg., 14F,
Shin-yokohama 2-3-12,
Kohoku-ku, Yokohama,
Kanagawa 222-0033, Japan
Tel: +81-45-471-0061
Fax: +81-45-471-0076

<http://edevic.fujitsu.com/fmd/>

North and South America

FUJITSU MICROELECTRONICS, INC.
3545 North First Street,
San Jose, CA 95134-1804, U.S.A.
Tel: +1-408-922-9000
Fax: +1-408-922-9179

Customer Response Center
Mon. - Fri.: 7 am - 5 pm (PST)
Tel: +1-800-866-8608
Fax: +1-408-922-9179

<http://www.fujitsumicro.com/>

Europe

FUJITSU MICROELECTRONICS EUROPE GmbH
Am Siebenstein 6-10,
D-63303 Dreieich-Buchsschlag,
Germany
Tel: +49-6103-690-0
Fax: +49-6103-690-122

<http://www.fujitsu-fme.com/>

Asia Pacific

FUJITSU MICROELECTRONICS ASIA PTE. LTD.
#05-08, 151 Lorong Chuan,
New Tech Park,
Singapore 556741
Tel: +65-281-0770
Fax: +65-281-0220

<http://www.fmap.com.sg/>

F0101

© FUJITSU LIMITED Printed in Japan

All Rights Reserved.

The contents of this document are subject to change without notice. Customers are advised to consult with FUJITSU sales representatives before ordering.

The information and circuit diagrams in this document are presented as examples of semiconductor device applications, and are not intended to be incorporated in devices for actual use. Also, FUJITSU is unable to assume responsibility for infringement of any patent rights or other rights of third parties arising from the use of this information or circuit diagrams.

The contents of this document may not be reproduced or copied without the permission of FUJITSU LIMITED.

FUJITSU semiconductor devices are intended for use in standard applications (computers, office automation and other office equipments, industrial, communications, and measurement equipments, personal or household devices, etc.).

CAUTION:

Customers considering the use of our products in special applications where failure or abnormal operation may directly affect human lives or cause physical injury or property damage, or where extremely high levels of reliability are demanded (such as aerospace systems, atomic energy controls, sea floor repeaters, vehicle operating controls, medical devices for life support, etc.) are requested to consult with FUJITSU sales representatives before such use. The company will not be responsible for damages arising from such use without prior approval.

Any semiconductor devices have inherently a certain rate of failure. You must protect against injury, damage or loss from such failures by incorporating safety design measures into your facility and equipment such as redundancy, fire protection, and prevention of over-current levels and other abnormal operating conditions.

If any products described in this document represent goods or technologies subject to certain restrictions on export under the Foreign Exchange and Foreign Trade Control Law of Japan, the prior authorization by Japanese government should be required for export of those products from Japan.